

Halton THL

Conical Ceiling Diffuser



Halton reserves the right to alter products without notice

- Horizontal or vertical air supply, suitable for both heating and cooling applications
- Adjustable throw pattern and pressure drop
- Installation flush to the ceiling, or exposed (especially in high spaces)
- Circular duct connection with gasket
- Openable front disk enables cleaning of the diffuser and ductwork

Accessories

Balancing plenum with adjustment function (PLC) or also with measurement function (TRI)

MATERIAL AND FINISHING

PART	MATERIAL	NOTE
Frame	Steel	
Front disk	Steel	
Finishing	Painted / White RAL 9010	Special colours available

QUICK SELECTION

qv	Pa	360	480	600	840	1080	1440	1920	2400	3000	3600	4800	6600	8400	10200	
	l/s	30	40	50	70	90	120	160	200	250	300	400	550	700	850	
	m ³ /h	108	144	180	252	324	432	576	720	900	1080	1440	1980	2520	3060	
THL-100 (R)	LpA	18	29	38	50											
	ΔPst	9	16	24	48											
	ΔPtot	18	31	49	96											
	Ld	-	-	-	-											
	Lmin	-	0,5	0,5	0,8											
	L0.2	1,0	1,4	1,8	2,2											
THL-125 (R)	LpA			19	30	39	49									
	ΔPst			10	20	32	58									
	ΔPtot			20	39	65	115									
	Ld			-	-	-	-									
	Lmin			0,5	0,5	0,8	1,4									
	L0.2			1,4	1,8	2,2	2,6									
THL-160 (R)	LpA				23	31	40	49								
	ΔPst				13	21	37	65								
	ΔPtot				20	33	58	183								
	Ld				-	-	-	-								
	Lmin				0,5	0,7	1,3	2,0								
	L0.2				1,8	2,2	2,8	3,6								
THL-200 (R)	LpA					20	27	35	42	48						
	ΔPst					11	20	36	56	88						
	ΔPtot					16	29	52	81	126						
	Ld					-	-	-	-	-						
	Lmin					0,5	0,7	1,3	1,9	2,6						
	L0.2					1,8	2,4	3,0	3,4	6,0						
THL-250 (R)	LpA							26	35	43	55					
	ΔPst							24	38	55	98					
	ΔPtot							34	54	78	138					
	Ld							-	-	-	-					
	Lmin							2,2	3,2	4,2	6,4					
	L0.2							3,4	4,4	5,2	7,0					
THL-315 (R)	LpA								21	28	40	52				
	ΔPst								19	28	49	93				
	ΔPtot								25	37	65	123				
	Ld								3,0	3,2	3,7	4,4				
	Lmin								2,4	3,4	5,2	7,8				
	L0.2								3,8	4,4	6,0	8,2				
THL-400 (R)	LpA											25	38	49		
	ΔPst											26	42	62		
	ΔPtot											38	61	90		
	Ld											3,5	4,0	4,4		
	Lmin											5,0	6,8	8,8		
	L0.2											5,8	7,4	9,0		

LpA values presented with room attenuation 4 dB (red 10m² - sab). When using room attenuation 8 dB (red 25m² - sab):
LpA - 4dB.

Pa Supply air cooling capacity, W
LpA A-weighted sound pressure level, reduced by total equivalent absorption surface of 10m², dB(A) red 10m² - sab
ΔPst Static pressure drop, Pa

ΔPtot Total pressure drop, Pa
Ld Distance from the supply unit, at which air jet detaches from ceiling, m
Lmin Minimum distance between central lines of two supply units, m (V3 = 0,25m/s at 1.8m height)
L0.2 Isothermal throw length, m when residual velocity of supply air jet 0,2 m/s
Room temperature (Tr) = 24 °C
Supply air temperature (Ta) = 14 °C
Room height = 2,8 m

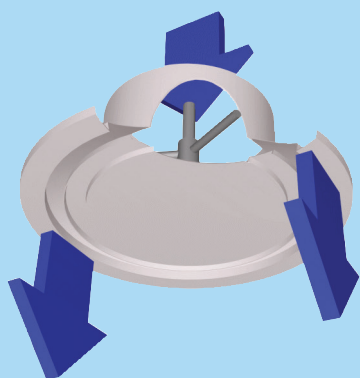

Compact jet

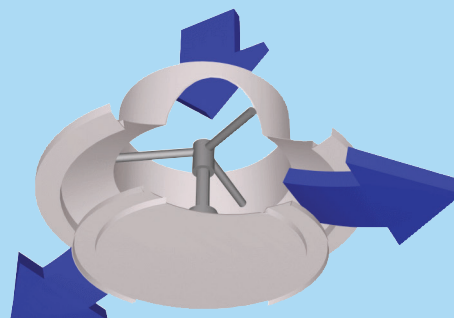

Radial Jet

Function

The THL is a ceiling diffuser with an adjustable low pattern.

The horizontal radial jet is used mainly in cooling applications and the vertical compact jet with warm supply air in heating applications.

The supply air pattern can be adjusted by rotating the front disk into the desired position.

The recommended maximum temperature difference in cooling applications between supply and room air temperature is 10 °C.

ACCESSORIES

ACCESSORY	CODE	DESCRIPTION
Balancing plenum	TRI	For balancing, equalising the air flow and attenuating the duct noise

DIMENSIONS

THL, manually operated

NS	ØW	H	H1	H2	ØD
100	286	97	25	9	99
125	286	97	25	9	124
160	286	97	25	9	159
200	354	81	30	10	199
250	440	84	39	12	249
315	546	102	52	14	314
400	685	135	70	14	399

THL with wax-bulb actuator

NS	ØW	H	H1	H2	H3	ØD
250	440	84	39	12	173	249
315	546	102	52	14	193	314
400	685	135	70	14	215	399

Product models

THL, manually operated

Changing manually the front disk position the throw pattern can be adjusted from radial to compact.

THL with wax-bulb actuator

Sizes 250, 315 and 400 can be equipped with a wax-bulb actuator, which work without any power supply. The front disk position changes according to the temperature of supply air.

The temperature range of the wax-bulb actuator is about 20 °C to 27 °C.

The time taken to change from radial to compact jet (or the other way around) is 10 - 20 minutes.

When warm air is supplied the piston of the wax bulb actuator keeps moving until the THL supply air pattern is vertical. When cold air is supplied, the THL supply air pattern is changed back to horizontal by means of a spring.

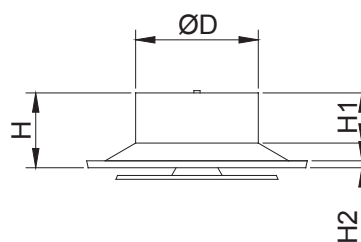
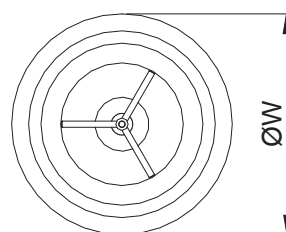

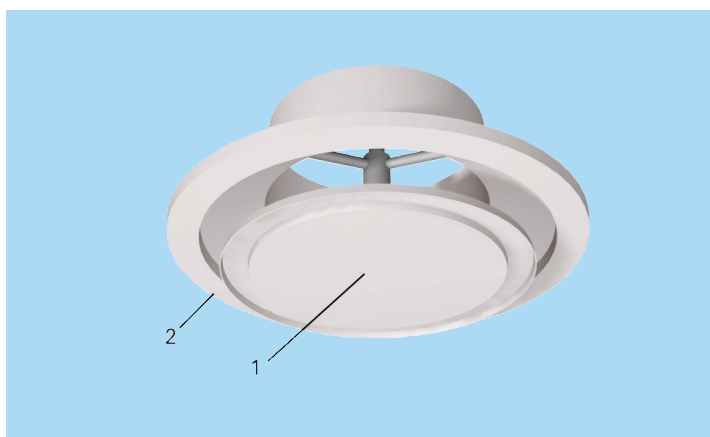

Installation

CODE DESCRIPTION

1	Front panel
2	Frame

The diffuser is connected either directly to the duct by screwing or riveting or alternatively to the TRI balancing plenum.

The minimum recommended safety distance upstream of the diffuser is 3xD.

Installation with TRI

The collar of TRI plenum can be installed either internally in the plenum or externally onto the bottom of the plenum.

The height of the unit for the external installation is presented in the table below.

When the collar is installed internally, the total height H3 is reduced by 60 mm.

The technical performance for the combination of supply air diffuser and TRI plenum is presented separately for the two different installations. See HIT Design software.

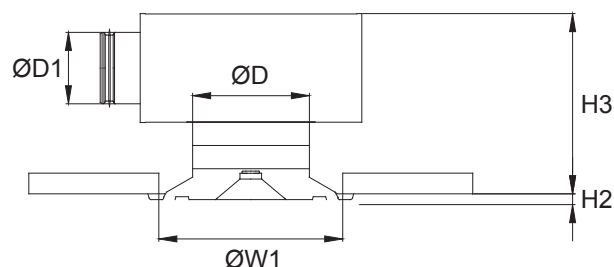

THL (ØD)	ØD1	TRI	ØW1	H2	H3
100	100	TRI-100-100	244	9	242-282
125	100	TRI-100-125	244	9	242-282
125	160	TRI-125-125	244	9	272-312
160	125	TRI-125-160	244	9	272-312
160	160	TRI-160-160	244	9	312-352
200	160	TRI-160-200	306	10	312-352
200	200	TRI-200-200	306	10	371-411
250	200	TRI-200-250	384	11	380-420
250	250	TRI-250-250	384	11	444-484
315	250	TRI-250-315	482	13	455-495
315	315	TRI-315-315	482	13	500-550
400	315	TRI-315-400	617	14	518-558

Supply, horizontal jet

THL 100, THL 125, THL 160

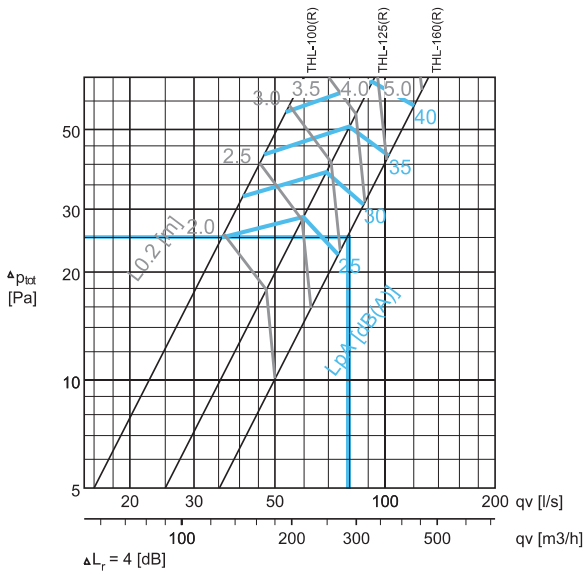

THL 200, THL 250, THL 315, THL 400

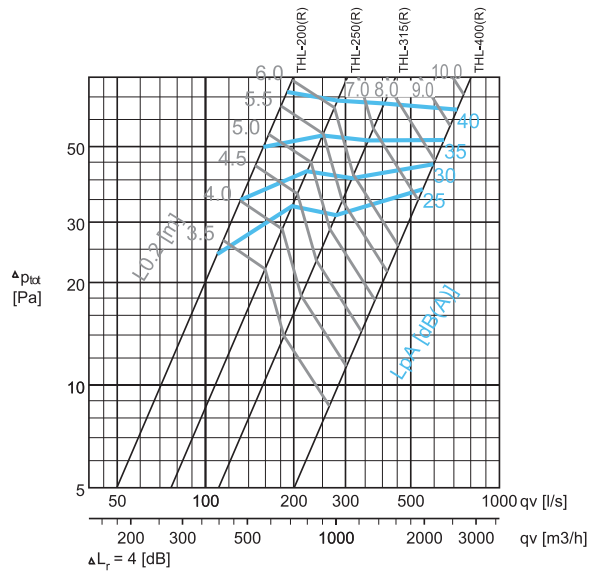

Selection example :

Requirements :	qv = 80 l/s	Selection : THL-160
	LpA < 30 dB(A)	LpA < 27 dB(A)
	L0.2 ≤ 3,5 m	L0.2 < 3,1 m
	Horizontal jet	ΔPtot = 26 Pa
		Opening: 12 mm

Note :

- Throw pattern with isothermal air, when the THL is installed flush with the ceiling.
- For applications with exposed duct mounting (no ceiling effect), the throw pattern is reduced approximately 30%, of the value given in the diagram.
- With a larger opening the pressure drop and sound level are reduced and throw pattern is shorter.
- The THL diagram data is based on the conventional adjustment positions shown in the table:

size	adjustment position (mm)
100	8
125	10
160	12
200	15
250	19
315	24
400	30

Pressure drop, throw pattern and sound data

Supply, vertical jet

THL 100, THL 125, THL 160

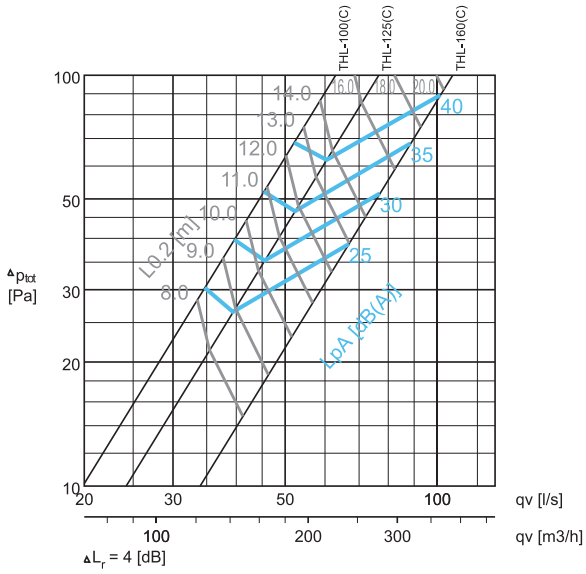

THL 200, THL 250, THL 315, THL 400

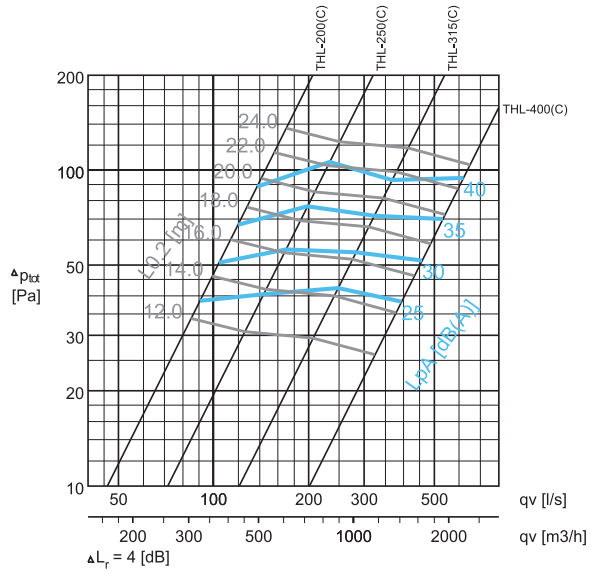

Note :

•Throw patterns are given for isothermal air. For non isothermal air, it is recommended that you refer to the Halton HIT Design.

The THL diagram data is based on the conventional adjustment positions shown in the table:

size	adjustment position (mm)
100	-4
125	-4
160	0
200	0
250	0
315	0
400	0

SOUND LEVEL DATA, HORIZONTAL JET

	qv		ΔP_{st} (Pa)	ΔP_{tot} (Pa)	F (Hz)					LpA [dB(A)]	NR	NC	
	(l/s)	(m ³ /h)			125	250	500	1000	2000				4000
THL-100(R)	36	130	13	25	33	31	29	23	13	3	25	20	19
	41	148	16	33	38	36	34	28	18	7	30	26	24
	47	169	21	42	43	41	39	33	23	12	35	31	29
	53	191	28	56	48	46	44	38	28	17	40	36	35
THL-125(R)	60	216	14	29	37	32	29	23	16	5	25	20	19
	70	252	19	38	42	37	34	28	21	10	30	25	24
	80	288	25	51	47	42	39	33	26	15	35	31	29
	93	335	34	68	52	47	44	38	31	20	40	36	35
THL-160(R)	74	266	14	22	36	34	28	19	9	3	25	20	18
	88	317	20	31	41	39	33	24	14	5	30	25	23
	102	367	27	42	46	44	38	29	19	10	35	30	28
	120	432	37	58	51	49	43	34	24	15	40	35	34
THL-200(R)	110	396	17	24	39	33	27	19	10	3	25	19	17
	132	475	24	35	44	38	32	24	15	6	30	24	22
	157	565	35	50	49	43	37	29	20	11	35	29	27
	190	684	50	72	54	48	42	34	25	16	40	35	33
THL-250(R)	199	716	24	33	38	34	27	20	10	3	25	20	17
	224	806	30	43	43	39	32	25	15	5	30	25	22
	253	911	39	55	48	44	37	30	20	10	35	30	28
	285	1026	49	69	53	49	42	35	25	15	40	36	34
THL-315(R)	278	1001	24	31	40	33	26	21	12	3	25	18	15
	315	1134	31	40	45	38	31	26	17	5	30	23	21
	358	1289	40	52	50	43	36	31	22	10	35	29	27
	405	1458	51	67	55	48	41	36	27	15	40	34	33
THL-400(R)	549	1976	26	37	38	33	27	21	8	3	25	19	17
	598	2153	31	44	43	38	32	26	13	5	30	24	22
	649	2336	36	52	48	43	37	31	18	10	35	29	28
	718	2585	45	64	53	48	42	36	23	15	40	34	33

LpA values presented with room attenuation 4 dB (red 10m² - sab). When using room attenuation 8 dB (red 25m² - sab): LpA - 4dB.
NR/NC noise criteria

SOUND LEVEL DATA, VERTICAL JET

	qv		ΔP_{st} (Pa)	ΔP_{tot} (Pa)	F (Hz)					LpA [dB(A)]	NR	NC	
	(l/s)	(m ³ /h)			125	250	500	1000	2000				4000
THL-100(C)	35	126	19	30	37	31	29	22	14	3	25	20	18
	40	144	24	40	42	36	34	27	19	5	30	25	24
	45	162	32	52	46	40	38	31	23	9	35	31	29
	52	187	42	68	52	46	44	37	29	15	40	36	35
THL-125(C)	39	140	20	27	36	31	28	20	12	3	25	20	18
	46	166	27	35	42	37	34	26	18	5	30	26	24
	52	187	36	47	47	42	39	31	23	10	35	31	29
	60	216	48	62	52	47	44	36	28	15	40	36	35
THL-160(C)	68	245	32	39	35	33	29	20	10	3	25	21	19
	78	281	42	51	40	38	34	25	15	5	30	26	25
	89	320	56	68	45	43	39	30	20	10	35	31	30
	103	371	74	90	50	48	44	35	25	15	40	36	35
THL-200(C)	91	328	34	39	31	32	29	22	10	3	25	21	19
	104	374	44	51	36	37	34	27	15	5	30	26	24
	120	432	58	67	41	42	39	32	20	10	35	31	30
	138	497	77	89	46	47	44	37	25	15	40	36	35
THL-250(C)	144	518	35	40	35	33	28	21	16	3	25	20	18
	170	612	49	56	40	38	33	26	21	7	30	25	23
	198	713	67	77	45	43	38	31	26	12	35	30	28
	233	839	93	106	50	48	43	36	31	17	40	35	34
THL-315(C)	248	893	36	42	38	33	27	22	12	3	25	18	17
	283	1019	47	55	43	38	32	27	17	5	30	24	22
	323	1163	61	72	48	43	37	32	22	10	35	29	27
	368	1325	80	93	53	48	42	37	27	14	40	34	33
THL-400(C)	394	1418	32	38	39	33	27	22	8	3	25	18	16
	458	1649	44	52	43	37	31	26	12	4	30	23	22
	532	1915	59	70	49	43	37	32	18	10	35	29	27
	619	2228	80	94	54	48	42	37	23	15	40	34	32

LpA values presented with room attenuation 4 dB (red 10m² - sab). When using room attenuation 8 dB (red 25m² - sab): LpA - 4dB.
NR/NC noise criteria

Adjustment

The THL itself has no means for airflow adjustment.

In order to enable airflow adjustment and measurement of airflow rate it is recommended that the diffuser be connected to the TRI balancing plenum. The supply airflow rate is determined by using the measurement and adjustment module MSM.

Detach the front disk or the whole diffuser and pass the tubes and control spindle through the side slot of the diffuser.

Replace the front disk or diffuser.

Measure the differential pressure using a manometer.

The airflow rate is calculated using the formula below.

$$q_v = k * \sqrt{\Delta p_m}$$

Adjust the airflow rate by rotating the control spindle until the desired setting is achieved.

Lock the damper position with a screw.

Replace the tubes and spindle into the plenum.

K-factor for installations with different safety distances (D= duct diameter)

TRI	> 8 x D	min 3 x D
100	6.0	7.5
125	9.9	12.6
160	16.9	21.9
200	28.3	31.0
250	47.9	51.5
315	78.6	-

The technical performance has been defined for radial and compact jet with the fixed cone module openings. The adjustment positions used are detailed in the table below.

SIZE	THL (R)	THL (C)
	Radial jet	Compact jet
100	8	-4
125	10	-4
160	12	0
200	15	0
250	19	0
315	24	0
400	30	0

Servicing

Measure the distance between the front disk and the upper frame in order to enable recovery of the same technical properties after cleaning.

Detach the front disk of the diffuser and clean the parts by wiping with a damp cloth.

Reinstall the front panel.

Suggested Specifications

The ceiling diffuser shall have a steel casing with an adjustable front disk and a spigot with integral gasket for connection to the circular duct.

The diffuser shall be painted white (RAL 9010) colour. The throw pattern of the diffuser shall be adjustable in radial or compact jet.

Product Code

THL-D(J)

D = Connection size
100, 125, 160, 200, 250, 315, 400

Specifics and accessories

CO = Colour
W White
X Special colour

MO = Actuator type
NA Not assigned
M1 Wax-bulb actuator (if D=250,315,400)

Code example

THL-100, CO=W,MO=NA

Sub products

TRI Plenum (Diffusers)

Pressure drop, throw pattern and sound data