

Halton USL

External Louvre

20/USL/0000/0408/EN

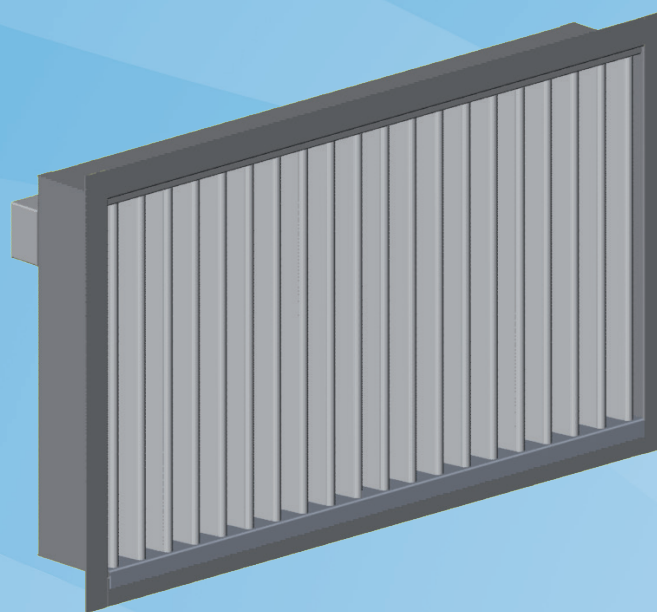

- External louvre for air intake to prevent rain, snow, leaf and animal ingress
- Very effective prevention of rainwater (97% / Eurovent) and snow (75 ...95%) penetration, due to labyrinth construction
- Detachable front grille; electrically heated rear grille
- Self-regulating heating cable with an operating voltage of 230 VAC
- Melted snow and water collection via a drip tray including a pipe connection
- Aluminium design

Product model options and Accessories

- Modular construction available for large sizes
- Models available with front grille made of polyester-painted or anodised aluminium
- Model available without self-regulating heating cable

MATERIAL AND FINISHING

PART	MATERIAL	FINISHING	NOTE
Front grille	Aluminium	Polyester-painted, anodised	Special colours available
Rear grille	Aluminium		
Frame	Aluminium		
Drip tray	Stainless steel AISI 316		
Heating cable			Manufacturer: TYCO Raychem, type: EM2-R, self-regulating
Electrical connection box	Plastic (Polypropylene)		IP65
Connection cable: 3 x 2.5 mm ²	Rubber (EPDM)		Length: 2 m

The drip tray under the rear grille is fitted with a drain connection. The grilles are fastened to the frame with screws.

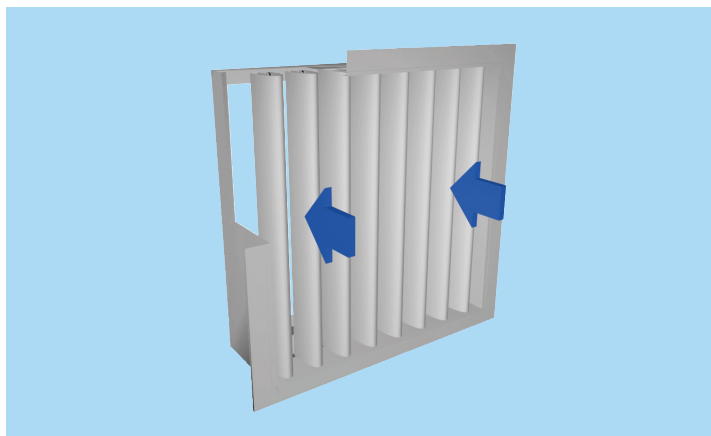

Function

Snow or water entering with the airflow is directed into the tapering slots of the front grille (A), increasing the air velocity.

The airflow is diverted into the space between the front and rear grille (B). The snowflakes hit the heated rear grille, which melts the snow.

The melted water flows down the rear blades (C) to the heated drip tray, from which it is led to the drain.

QUICK SELECTION

WxH [mm]	q(1m/s)		q(1,5 m/s)	
	[l/s]	[m³/h]	[l/s]	[m³/h]
400x400	160	576	240	864
400x600	240	864	360	1296
600x400	240	864	360	1296
600x600	360	1296	540	1944
600x1200	720	2592	1080	3888
800x800	640	2304	960	3456
1000x1000	1000	3600	1500	5400

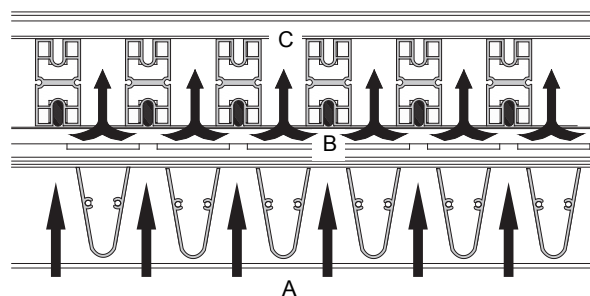

Pressure drop and sound data

USL-1000x1000

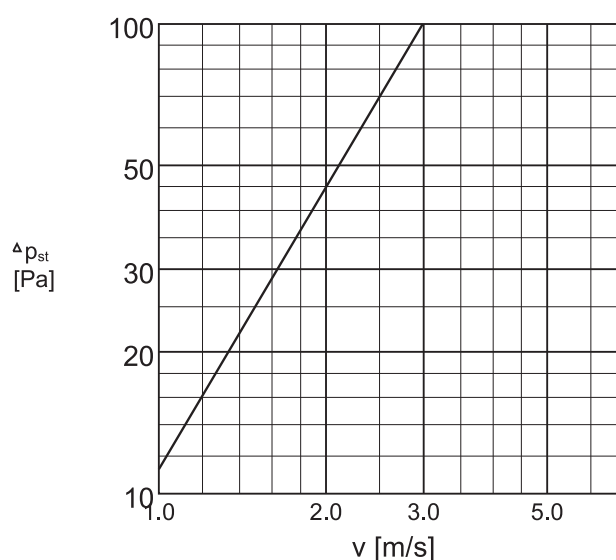

DIMENSIONS

L	H
400,+50,...,10000	400,+50,...,2000

The distance between the front vertical blades is 50 mm. The free area is about 40% of the nominal opening.

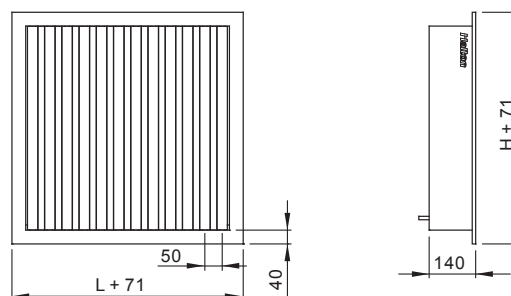

Heating capacity

The maximum heating capacity of the rear grille and drip tray's self-regulating heating cable is 2400 W/m² when the outdoor temperature is -18 °C.

The operating voltage is 230 VAC / 50Hz.

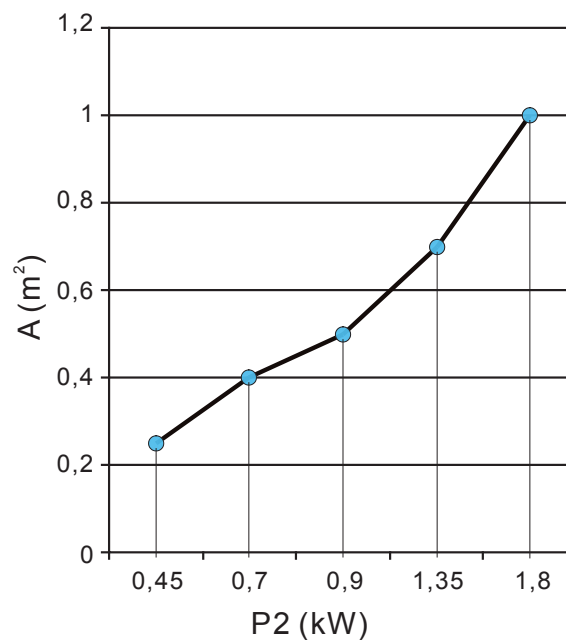
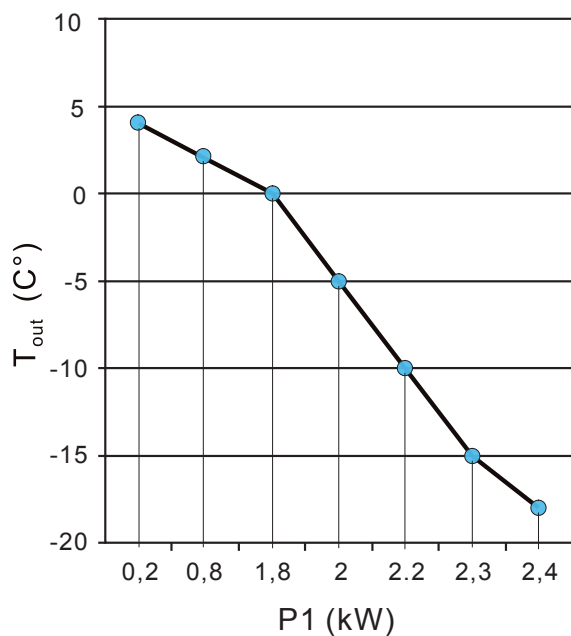

T_{out} (°C) = Outdoor temperature
 A (m²) = Face area of louvre
 P1 (kW) = Heating capacity
 P2 (kW) = Heating capacity (without outdoor temp. of 0 °C)

Water penetration prevention

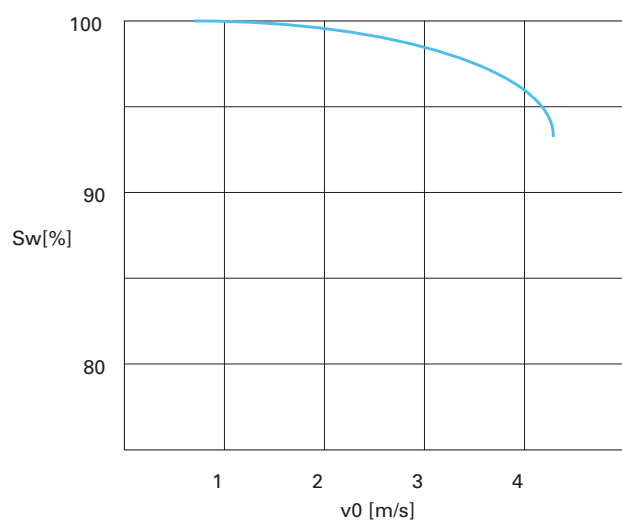

v0 Face air velocity

Snow penetration prevention

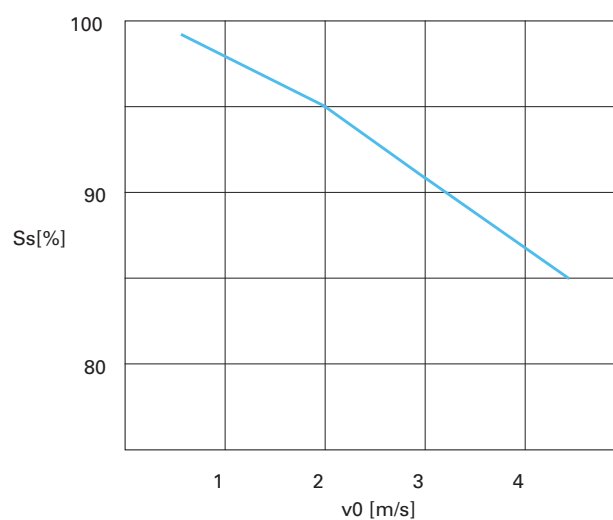

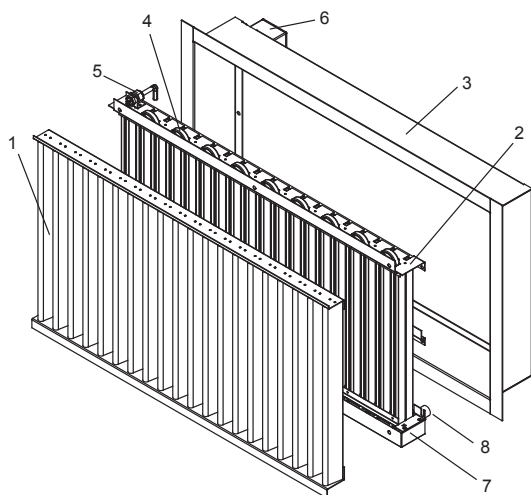

Installation

CODE	DESCRIPTION
1	Front grille
2	Rear grille
3	Installation frame
4	Heating cable
5	Cable clamp
6	Cable connection box
7	Drip tray
8	Connection tap

Fasten the louvre in place by screwing the installation frame into a wall opening, the screw holes in the flanges being site-drilled.

The dimensions of the louvre are given as the nominal dimension. The installation opening shall be about 20 mm wider than the nominal dimension.

Because of the connections, there should be an installation space of at least 100 mm behind the louvre.

Mounting of installation frame

- ATTACHMENT POSSIBILITIES
- WEDGE ANCHOR or SCREW attachment

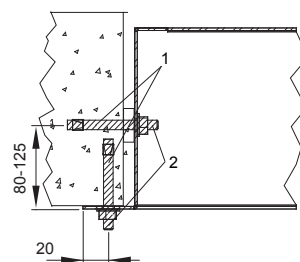

CONCRETE WALL

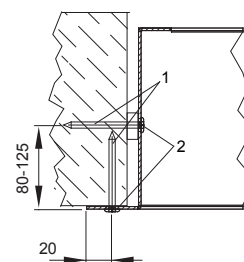

WOODEN WALL

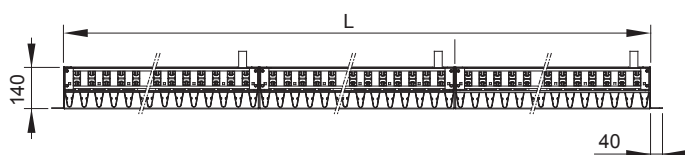

In a modular installation, the frames of adjacent modules are bolted together before installation of the louvre sections.

In large modular installation (height > 2000 mm), the louvres shall be installed with a supporting installation construction (not included in the delivery).

Electrical wiring

Electrical connections shall be made with a connection box. Between the grille and connection box there is a two-metre-long rubber cable.

DELIVERY LIMIT

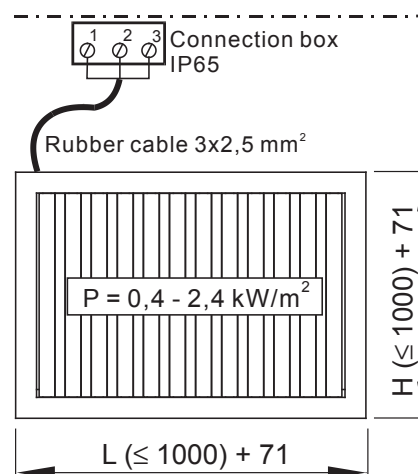

DELIVERY LIMIT

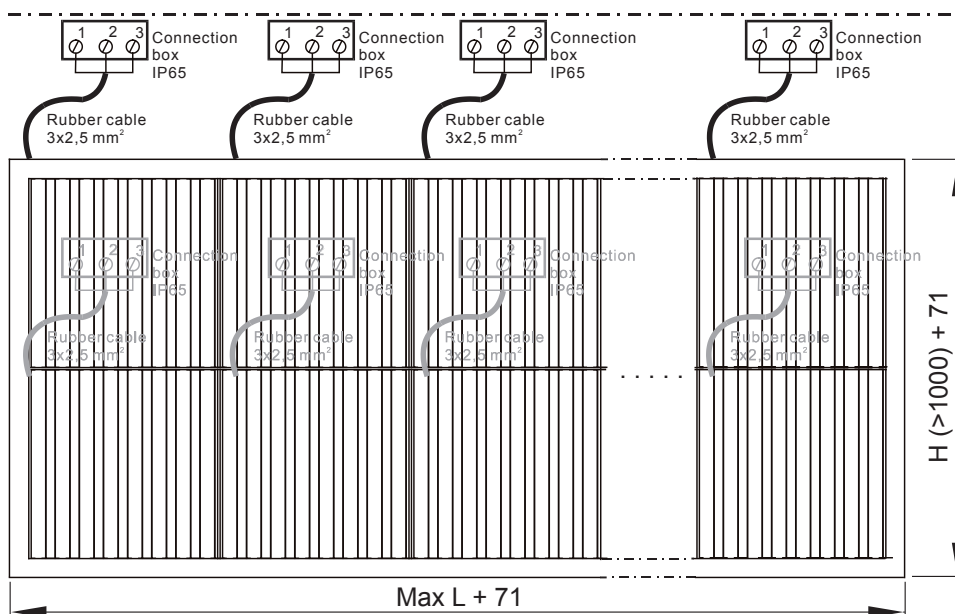

In the modular construction there is a separate connection box in each module. This must be taken into account when electrical drawings are being drafted.

Connect the drip tray drain tap to the drain pipework. The drip tray connection is delivered loose.

When necessary, the louvre is cleaned with a soft brush.

Suggested specifications

The external louvre shall have a snow prevention capacity of at least 70%, and 90% for rainwater (Eurovent 2/5).

The rear grille shall be equipped with an electric self-regulating heating cable providing a maximum heating capacity of 2400 W/m² when the outdoor temperature is -18 °C, with an operating voltage of 230 VAC.

The outdoor louvre shall be equipped with a connection box (IP 65).

The drip tray shall be provided with a drain tap R3/4" connection.

For large (over 1000 x 1000 mm) openings, the grille shall be supplied in modular form. Each louvre of a module shall have an independent connection box and drain connection.

Product code

S = model

A Standard

B Louvre without heating

W = width

400, +50, ..., 10000

H = height

400, +50, ..., 2000

Specifics and accessories

FI = finishing

NA No finishing

PN Painted

AN Anodised (colour: aluminium)

CO = colour

G Grey

X Special colour

Code example

USL/A-400-400, FI=NA