

# Halton - Capture Ray™ - Shining a bright light on the performance of UV on kitchen emissions

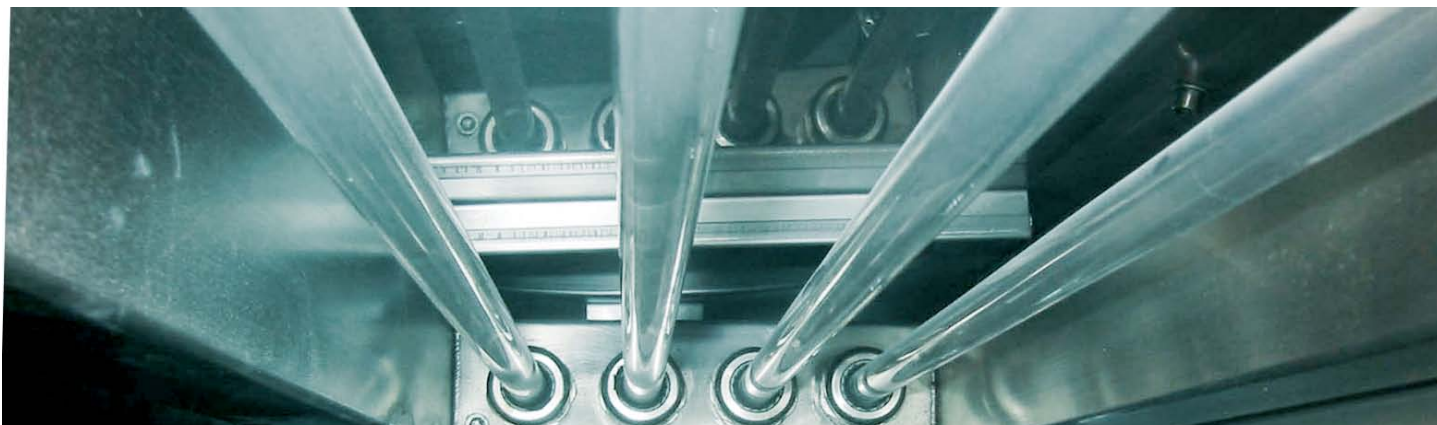



## Clean Operation, Clean Benefits

Halton Capture Jet® technology combined with innovative Capture Ray™ ultra-violet light technology. Scientifically proven results provide fire safety, reduced operating costs and lower environmental impact.

- Cleaner exhaust ducts and plenum for improved hygiene and safety
- Duct cleaning costs are reduced
- Fast payback time and lower operating costs
- Low air flow rates and energy savings with Capture Jet® technology.
- Comfortable working conditions and increased productivity in the kitchen
- Scientifically tested system with world-wide references

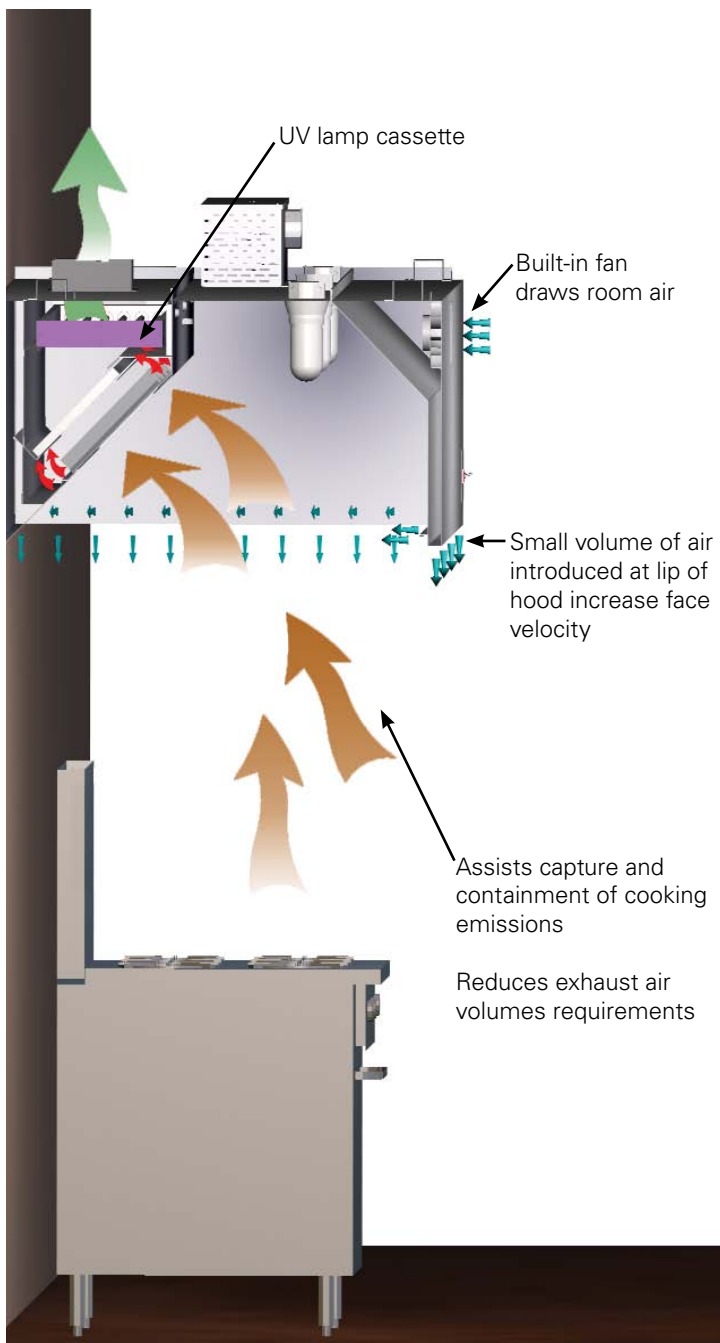

# What is UV?

Light is the most common form of electromagnetic radiation (EMR) that the average person is aware of. Light is only a very small band within the electromagnetic spectrum. Cosmic rays, X-rays, radio waves, television signals, and microwaves are other examples of EMR. EMR is characterized by its wavelength and frequency. Wavelength is defined as the length from the peak of one wave to the peak of the next, or one oscillation (measured in meters). Frequency is the number of oscillations in one second (measured in Hertz).

Sunlight is the most common source of ultraviolet radiation (UVR) but there are also many other sources. UVR emitting artificial light sources can be produced to generate any of the UVR wavelengths by using the appropriate materials and energies.

Ultraviolet radiation is divided into three categories - UVA, UVB and UVC. These categories are determined by their respective wavelengths. Ultraviolet A radiation is the closest to the wavelength ranges of visible light. Ultraviolet B radiation is a shorter length, more energetic wave. Ultraviolet C radiation is the shortest of the three ultraviolet bands and is used for sterilization and germicidal applications.

UV technology has been known since the 1800's. In the past it has been utilized in hospitals, wastewater treatment plants and various industry applications.

Halton has developed an applications to harness the power of ultraviolet technology in the commercial kitchen industry.

## UV - What does it do?

Ultraviolet light reacts to small grease particulate and volatile organic compounds (VOC) generated in the cooking process in two ways, by exposing the effluent to light and by the generation of ozone (UVC).

As is commonly known, effluent generated from the cooking process is grease. From a chemical standpoint, a fatty substance contains double bonds, which are more reactive than single bonds. By using light and ozone, it is possible to attack these double bonds and consequently, break them. This results in a large molecule being broken down into two smaller molecules. Ozone and Hydroxyl radicals then oxidize and alter the small grease molecules.



# UV-C Design considerations:

Temperature plays a critical role in UV-C performance. When temperatures get above 160°F the efficiency of UV diminishes. For example, average entering air temperature of a cook-line with typical under-fired broiler is 100-110°F. If plenum temperatures are over 160° F temperatures – this is a unique cook-line and should be evaluated for UV-C effectiveness.

There is also a loading factor. Vapor can be as much as 40% of effluent. Mechanical extraction will not take this out. UV can be overloaded and an estimate must be made to determine the levels of vapor and time frame – but only if temperature conditions exist for UV-C performance, – loading is a secondary issue – the hotter the surface, generally more vapor.



## With Halton - it's always a total solution

Total system efficiency is the starting point for a fully operable UV system. The system design evaluates both exhaust and supply based on actual heat loads and Capture Jet® efficiency.

Halton Capture Jet® high efficiency hoods are available with Capture Ray™ UV technology. Capture Jet® hoods create a healthy and productive working environment by preventing the heat and impurities produced by cooking emissions from spreading into the work area. Compared to conventional exhaust-only hoods, Capture Jet® is 30% more efficient while also reducing energy consumption due to lower airflow rates.

This solution also includes the most advanced mechanical KSA filters, removing 95% of grease particles sized eight microns and above. Organic compounds are reduced by combining the best mechanical filtration available with the lowest possible operating air flows, thus giving the optimal residence time to the UV light and the longest working time to breakdown the grease molecules. Low pressure loss reduces energy consumption. These hoods also include T.A.B. system for easy testing and balancing.

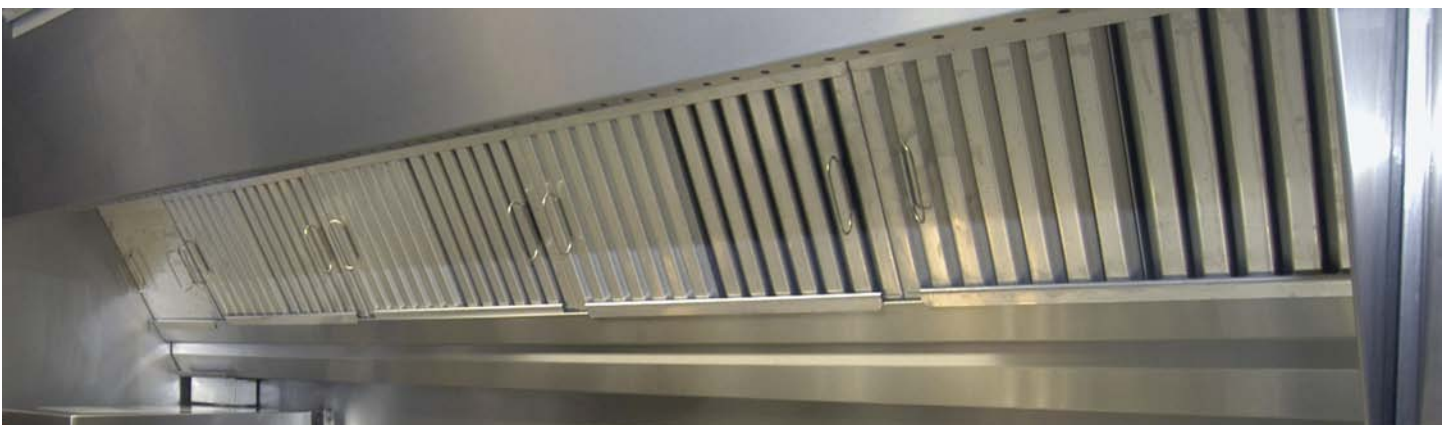

# The 1<sup>st</sup> Step in efficient UV conversion is to have...

## KSA Filters: The most efficient mechanical grease extractor on the market...!!!

Total system efficiency is important to overall system performance which makes it extremely important the mechanical extractor utilized in the system removes as much grease particulate as possible.

Halton's KSA filter is a centrifugal filter that allows grease laden air to enter multiple chambers and rotate - slinging grease particles to the outer walls and removing them from the exhaust air stream. Think of soaking a towel in water and swinging it over your head...

1. Exhaust air enters through a slot in the filter
2. Exhaust air rotates through the filter, impinging grease on the filter walls
3. The cleaner air exits the top and bottom of the filter

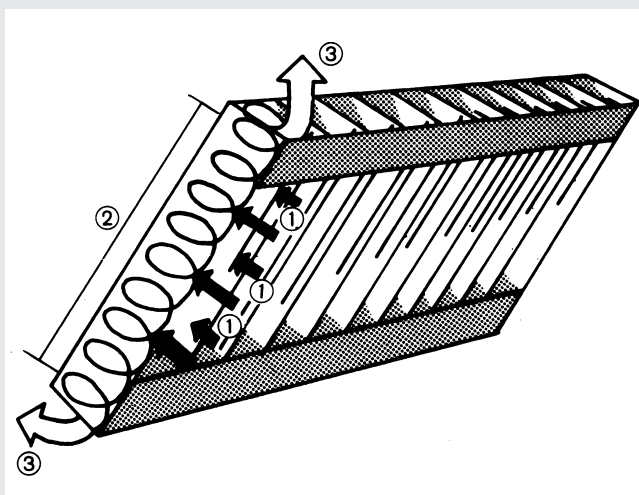

## Extraction Efficiency KSA vs Baffle Filters

GREASE FILTER	PM Extraction Efficiency (%)			Overall Grease Extraction Efficiency (%)		
	GRIDDLE	FRYER	BROILER	GRIDDLE	FRYER	BROILER
KSA 500, 144 cfm/ft	74.6	79.1	59.1	48.3	44.4	36.5
KSA 500, 196 cm/ft	81.2	85.6	64.7	52.5	47.7	40.0
KSA 500, 274 cfm/ft	84.7	88.6	67.5	54.8	49.3	41.7
KSA 500, 365 cfm/ft	88.5	92.0	71.0	57.3	51.0	43.9
KSA 330, 144 cfm/ft	78.7	82.9	62.5	50.9	46.3	38.6
KSA 330, 196 cfm/ft	89.1	93.4	71.0	57.7	51.7	43.9
KSA 330, 274 cfm/ft	87.9	91.2	70.5	56.8	50.6	43.6
Baffle, 144 cfm/ft	19.0	20.5	14.9	12.3	14.0	9.2
Baffle, 196 cfm/ft	28.0	29.9	22.2	18.1	18.9	13.7
Baffle, 274 cfm/ft	51.5	54.8	40.7	33.3	31.8	25.2
Baffle, 365 cfm/ft	65.2	69.3	51.6	42.2	39.3	31.9

Research based on VDI 2052, Part 1, "Ventilation Equipment for Kitchens. Determination of Capture Efficiency of Aerosol Separators in Kitchen Exhaust. Note the bottom chart KSA 330 @ 196 cfm/ft compared with the baffle filter at 196 cfm/ft. On the top chart, note how the KSA efficiency remains high even when the filters are not cleaned and loading occurs.

# Capture Ray™ UV-C Hoods

Many kitchens require emission control in their exhaust systems, to comply with the increasing demand for environmentally friendly operations. Halton Capture Ray™ hoods are based on Halton's patented Capture Jet® solution, advanced mechanical KSA extractor technology, and a UV-C system for the destruction of grease generated in the cooking process. Our UV-C technology is scientifically tested and includes all the necessary safety features. Together, these features result in clean ducts and improved fire safety.

Odor control, smoke, and the appearance of exterior exhaust ducts are factors that need particularly careful consideration in food service environment design. Halton's advanced air purification system is designed to be incorporated into commercial kitchen ventilation systems where control of airborne pollutants at the discharge point is a requirement.

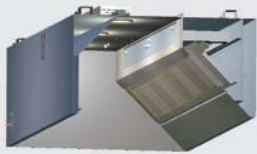

## **KVE-UV - Capture Jet® Hood with UV Technology**

KVE Capture Jet® hood equipped with high efficiency KSA grease extractors and Ultraviolet cassette(s) with complete controls and safety features.

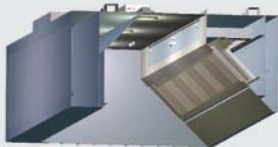

## **KVC-UV - Capture Jet® Hood with Supply Air and UV Technology**

KVC Capture Jet® hood equipped with low velocity supply air, high efficiency KSA grease extractors and Ultraviolet cassette(s) with complete controls and safety features.

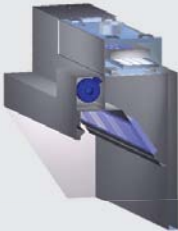

## **KVL-UV - Backshelf Capture Jet® Hood with UV Technology**

KVL backshelf type Capture Jet® hood equipped with high efficiency KSA grease extractors and Ultraviolet cassette(s) with complete controls and safety features.

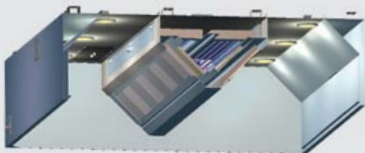

## **KVW-UV - Capture Jet® Island Hood with UV Technology**

KVW Capture Jet® Island hood equipped with a low velocity supply air unit, high efficiency KSA grease extractors and Ultraviolet cassette with complete controls and safety features.





# System Enhancements

Halton EcoloAir™ units meet the increasingly stringent environmental demands and building regulations that have placed considerable limitations on the location of commercial kitchens. Odor control, smoke and the appearance of exterior exhaust ducts are all factors that need particularly careful consideration in foodservice environmental design.

Halton's ECOsystem is proactive in identifying filter replacement requirements by providing the end user with a clear visual indicator. The indicator shows filter life as a percentage filter loaded for each filtration stage or if filters are missing so operations can plan regular maintenance. With an optional web link, the system will send an email or text message to a designated service provider to schedule filter change during routine maintenance. This prevents any downtime during critical operating periods. Halton also offers the ECOsystem to be retrofitted to provide all the about mentioned benefits for already installed EcoloAir Systems.



EcoloAir™

Each ventilation design presents its own unique challenges, for that reason Halton offers a line of hood accessories to address those project specific issues.

**M.A.R.V.E.L** – Model based Automated Regulation of Ventilation Exhaust Levels – Demand Control system using infrared sensing to match exhaust to appliance activities. Use to save energy.

**Water Wash** – The automatic wash-down systems for hoods, which combine the Capture Jet® system's efficiency with filter and exhaust plenum cleaning. These maintain grease extractor performance and keep the entire system running at peak performance. With our advanced design the filters do not have to be removed from the hood, reducing labor costs.

**ABD** – Automated Balancing Damper – works with Halton's M.A.R.V.E.L. system for multiple hoods connected to a common exhaust system

**MBD** – Manual Balancing Dampers – for easy balancing of exhaust airflow for multiple hoods connected to a common exhaust system

**TKHVAC™** - Total Kitchen HVAC® reduces energy consumption and greenhouse gases while improving comfort through temperature and humidity control.

**Fire Suppression** - Fire Suppression system can be designed to economically fit particular sizes of kitchen equipment and canopy arrangements.

## Halton – Enabling wellbeing in indoor environments

Halton is a family owned company specializing in indoor climate and indoor environment products, services and solutions. Halton's aim is to create comfortable and safe indoor environments with energy-efficient and sustainable life cycle.

Halton solutions range from public and commercial buildings to industry, commercial kitchen and restaurant applications. Halton is also one of the most recognized indoor climate solution providers for marine and offshore applications. Areas of expertise and product ranges cover air diffusion, airflow management, fire safety, kitchen ventilation, air purification and indoor environment management.

Halton operates in 23 countries around the world. Headquarters are located in Finland and in the USA. Production facilities are located in Finland, France, Germany, Hungary, the UK, the USA, Canada and Malaysia. Indoor environment laboratories are located in the USA, France and Finland.

[www.haltoncompany.com](http://www.haltoncompany.com)

Halton Company  
101 Industrial Drive  
Scottsville, KY USA 42164  
Tel: (270) 237-5600 | Fax: (270) 237-5700

Halton Indoor Climate Systems  
1021 Brevik Place  
Mississauga, ON, Canada L4W 3R7  
Tel: (905) 624-0301 | Fax: (905) 624-5547